

# Multilin™ B90

## Secure, Dependable and Scalable Bus Differential Protection System from LV to EHV Busbars

The Multilin B90 bus differential system provides fast and secure low impedance bus protection for reconfigurable LV to EHV busbars. Use one B90 to protect up to 8 feeders and use three or more B90s together in a centralized phase-segregated architecture to protect up to 24 feeders. Many busbar applications, such as single, double, triple, breaker-and-a-half, with or without transfer bus, can be protected using the B90. The B90 is ideally suited for applications where high impedance schemes are typically used.

The Multilin B90 comes with a variety of versatile features truly integrating protection, monitoring, metering, communication and control in one easy-to-use device.

### Key Benefits

- High-speed protection algorithm for enhanced stability with trip times of 0.75 power cycle
- Superior CT saturation detector capable of detecting CT saturation even with only 2 msec of saturation free current for enhanced stability during fault conditions
- Suitable for different bus configurations and a scalable architecture, protecting systems with up to 24 feeders
- Pre-engineered bus protection systems, utilizing experienced GE Digital Energy application engineers to develop busbar protection schemes matching your specific configurations
- Advanced IEC 61850 Ed. 2 certified implementation, complete settings via SCL files enable resource and platform managing optimization and reduce cost of ownership
- Routable GOOSE (R-GOOSE) enables customer to send GOOSE messages beyond the substation, which enables WAPC and more cost effective communication architectures for wide area applications
- Increased network availability via failover time reduced to zero through IEC® 62439-3 "PRP" support
- CyberSentry™ provides high-end cyber security aligned to industry standards and services (NERC® CIP, AAA, Radius, RBAC, Syslog)
- Advanced fault and disturbance recording, including internal relay operating signals, eliminating the need for external recording devices
- Supports IEEE C37.111-1999/2013, IEC 60255-24 Ed 2.0 COMTRADE standard

### Applications

- Re-configurable multi-section busbar with up to 24 feeders
- Single bus, breaker-and-a-half busbar configurations, double bus and triple bus with and without bus couplers



## Protection and Control

- Multi-zone bus differential protection with restrained and unrestrained function
- Fast and reliable CT saturation detection
- Breaker failure & End Fault (dead zone) protection
- CT ratio mismatch compensation
- Dynamic bus replica
- Backup time, instantaneous overcurrent elements and undervoltage function

## Communications

- 3 independent Ethernet ports for simultaneous & dedicated network connections with IEEE 1588 support
- Supported industry protocols: IEC 61850 Ed. 2, SFTP, MMS File Transfer Service, DNP 3.0, Modbus Serial/TCP, IEEE 1588, IEC 60870-5-104 and 103, PRP, SNTP, HTTP, TFTP

## Cyber Security

- CyberSentry™ provides high-end cyber security aligned to industry standards and services (NERC® CIP, AAA, Radius, RBAC, Syslog)
- Setting for security audit trails, tracking changes to device configurations

## Monitoring & Metering

- Isolator monitoring (up to 48) and alarming
- CT trouble monitoring & VT supervision
- Advanced recording capabilities with high-capacity event recorder, configurable and extended waveform capture and data logger
- Metering: current, voltage, frequency, and harmonics
- Supports IEEE C37.111-1999/2013, IEC 60255-24 Ed 2.0 COMTRADE standard



## Protection and Control

As part of the UR family of Protection & Control devices, the B90 offers a high degree of modularity in its design and functionality, providing superior performance while meeting the toughest requirements of the marketplace. Advanced protection and control features of this relay includes:

### Segregated Bus Differential Protection

The B90 provides fast and secure low impedance bus protection with sub-cycle tripping times averaging 0.75 cycles. Multiple phase-segregated zones of differential protection are available in the B90. The primary protection is based on differential and directional protection principles, and uses a dedicated CT saturation mechanism for additional through-fault stability. This mechanism is capable of detecting saturation of CTs as quickly as two milliseconds into an external fault. The overall system costs can be reduced with the B90 since there is no need for dedicated or interposing, external CTs. It offers extreme flexibility, including a CT ratio mismatch of up to 32:1 between feeders, making the B90 an ideal solution in a wide variety of bus differential applications.

### Architecture

The B90 is based on a centralized phase-segregated architecture that does not rely on extensive communications between IEDs,

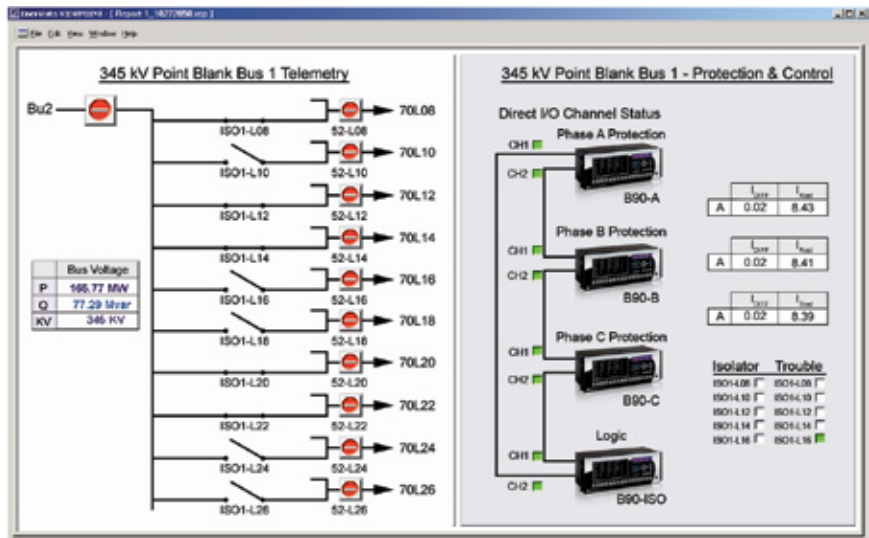

The B90 is the single point for protection, control, metering, and monitoring in one integrated device that can easily be connected directly into DCS or SCADA monitoring and control systems like Viewpoint Monitoring as shown.

an approach that increases overall reliability. This architecture allows for greater flexibility and is scalable to any low impedance busbar protection application, all in a relatively small form factor. Each unit in the system is capable of exchanging digital states quickly and reliably over direct I/O, allowing the user to distribute input and output contacts in various IEDs. The B90 protection system can incorporate as few as one IED and as many as five IEDs to

accommodate a wide range of applications. This scalability and flexibility allows for optimum hardware utilization with an overall lower system cost, which was not previously possible. A single B90 configuration is available to protect up to 8 feeders. A more typical B90 configuration for non-re-configurable busbars, without breaker fail protection, consists of three B90s. This configuration can protect up to 24 feeders. Each B90 in the system can

## Functional Block Diagram

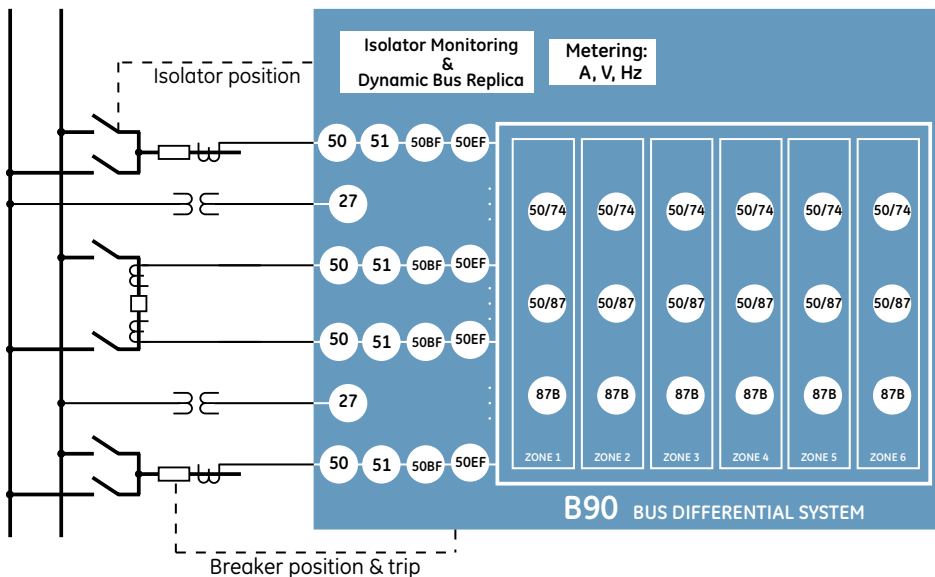

B90 - Protection, Metering, Monitoring and Control

### ANSI® Device Numbers & Functions

DEVICE NUMBER	FUNCTION
27	Undervoltage
50	Instantaneous Overcurrent
51	Time Overcurrent
50/74	CT Trouble
87B	Bus Differential
50/87	Unrestrained Bus Differential
51	Time Overcurrent
50BF	Breaker Fail
50EF	End Fault Protection

also be configured to support multiple I/O configurations (up to 48 inputs or up to 18 outputs on each unit). If breaker failure, isolator monitoring functions, and more I/O points are needed, an additional B90 can be added into the system. A fifth unit can also be added for even more I/O capabilities.

### Dynamic Bus Replica

The B90 provides a dynamic bus replica for each zone of differential protection. Built-in programmable logic removes the need for external auxiliary relays, and provides the ability to include or exclude currents dynamically from the differential zone. This allows the B90 to follow the actual busbar configuration with no external switching of CT circuits required. The B90 also avoids blind and overtripping spots in simple bus configurations. Reliability is increased and costs reduced by eliminating auxiliary relays that would otherwise be used for switching physical currents. The ability to monitor auxiliary switches and a contact discrepancy alarm also provides increased security.

### Breaker Failure Protection

Three-pole breaker failure (BF) protection is available. The B90 system provides for up to 24 BF elements that can respond to currents and/or auxiliary contacts. The current supervision provides fast reset time and separate settings for low-set and hi-set supervision in the phase IEDs. The BF can be initiated internally from

the busbar protection or externally via input contacts or communications.

### Overcurrent Protection

Backup protection is available with instantaneous and time overcurrent functions for each current input of the B90 system. For supervision purposes, an undervoltage function is also provided for each voltage input of the B90 system.

- Time O/C elements can individually be set to use IEEE, IEC or custom FlexCurves™

### End Fault (Blind Spot) Protection

The location of the current transformer normally limits the zone of the busbar protection and can create a blind spot when the isolator is open. The section between the current transformer and the circuit breaker can be effectively protected by means of the end-fault protection. In the event of a fault, instantaneous and selective tripping of the busbar section or inter-tripping of the circuit breaker at the remote end can be configured.

### Check-Zone

The B90 provides for multiple zones of differential protection. One zone can be configured to encompass the entire busbar in order to act as a supervisory check-zone for other zones of protection.

### CT Trouble Monitoring

One CT trouble monitoring function is provided for each zone of differential protection. The element is a definite time TOC function responding to a differential current. The CT trouble element shall be used in conjunction with undervoltage supervision or a check-zone.

### Advanced Automation

The B90 incorporates advanced automation features including powerful FlexLogic™ programmable logic, communication, and SCADA capabilities that far surpass what is found in the average bus protection relay. The B90 integrates seamlessly with other UR relays for complete system protection.

### FlexLogic

FlexLogic is the powerful UR-platform programming logic engine that provides the ability to create customized protection and control schemes, minimizing the need and associated costs of auxiliary components and wiring. With 1024 lines of FlexLogic, the B90 can be programmed to provide required tripping logic along with custom scheme logic.

### Typical B90 Configurations

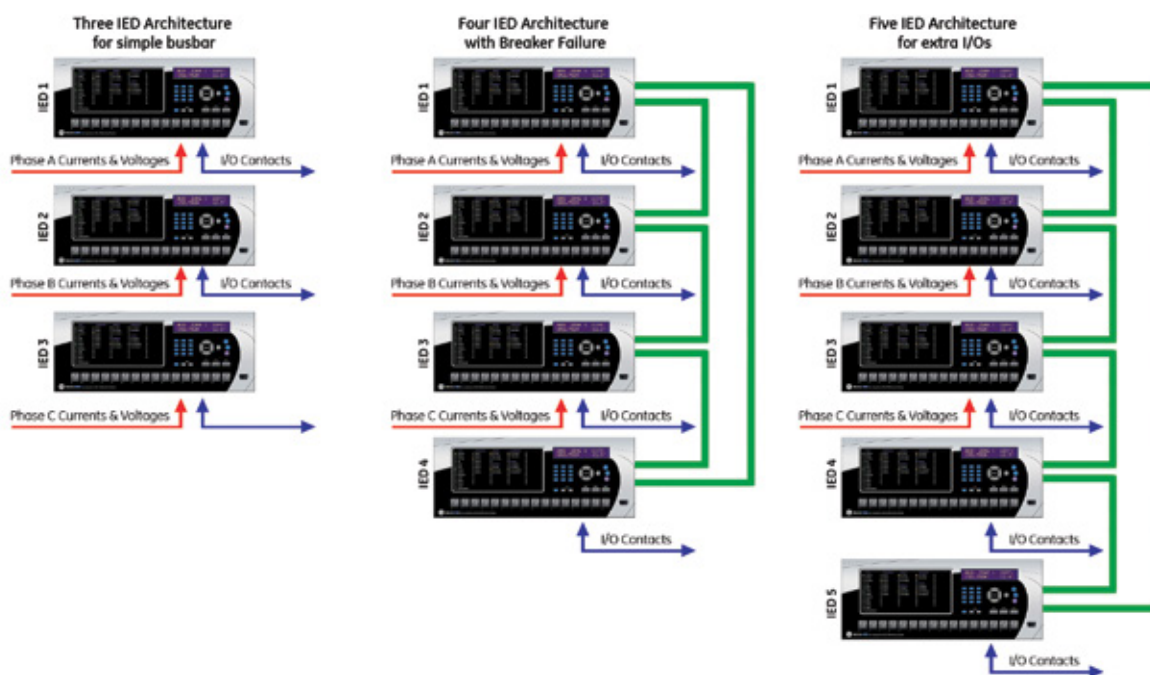

**Scalable Hardware**

The B90 is available with a multitude of I/O configurations to suit the most demanding application needs. The expandable modular design allows for easy configuration and future upgrades.

- Multiple CT/VT configurations allow for the implementation of many different schemes
- Flexible, modular I/O covering a broad range of input signals and tripping schemes
- Types of digital outputs include trip-rated Form-A and Solid State Relay (SSR) mechanically latching, and Form-C outputs
- Form-A and SSR outputs available with optional circuit continuity monitoring and current detection to verify continuity and health of the associated circuitry
- Mechanically latching outputs can be used to develop secure interlocking applications and replace electromechanical lockout relays

**Monitoring and Metering**

The B90 includes high accuracy metering and recording for all AC signals. Voltage, and current are built into the relay as a standard feature. Current and voltage parameters are available as total RMS magnitude, and as fundamental frequency magnitude and angle.

**Fault and Disturbance Recording**

The advanced disturbance and event recording features within the B90 can significantly reduce the time needed for postmortem analysis of power system events and creation of regulatory reports. Recording functions include:

- Sequence of Event (SOE)
  - 1024 time stamped events
- Oscillography
  - Supports IEEE C37.111-1999/2013, IEC 60255-24 Ed 2.0 COMTRADE standard
  - 64 digital & up to 40 analog channels
  - Events up to 45s in length

- Data Logger and Disturbance Recording
  - 16 channels up to 1 sample/cycle/channel
- Fault Reports
  - Powerful summary report of pre-fault and fault values

The very high sampling rate and large amount of storage space available for data recording in the B90 can eliminate the need for installing costly stand-alone recording equipment.

**Advanced Device Health Diagnostics**

The B90 performs comprehensive device health diagnostic tests at startup and continuously during run-time to test its own major functions and critical hardware. These diagnostic tests monitor for conditions that could impact security and availability of protection, and present device status via SCADA communications and front panel display. Providing continuous monitoring and early detection of possible issues help improve system uptime.

**Built-in Advanced Disturbance Recording**

The built-in advanced disturbance recording function allows users to view the COMTRADE files and troubleshoot bus faults. The internal operation of the B90 elements, logic, and outputs can be monitored in real-time to simplify commissioning and troubleshooting procedures. Two cases are shown here:

**External Fault:**

Even with heavy CT saturation and with only 1 msec of saturation free current, B90 is stable for through faults. See the directional comparison element output, which adds additional security to the bus differential function.

**Internal Fault:**

For internal faults the CT saturation flag is not set and the directional element output is safely ignored, resulting in an operating time of less than 10 msec.

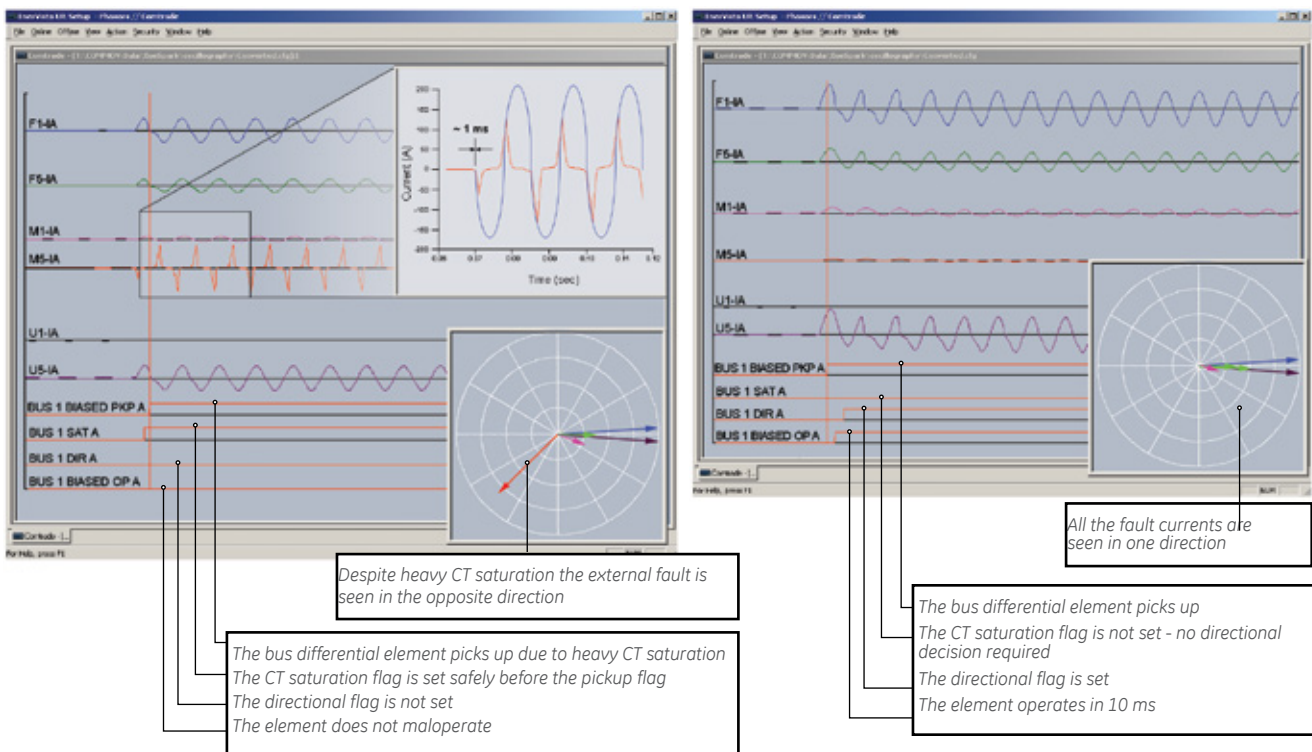

- Comprehensive device health diagnostic performed at startup
- Monitors the CT/VT input circuitry to validate the integrity of all signals

## Cyber Security – CyberSentry UR

CyberSentry UR enabled UR devices deliver full cyber security features that help customers to comply with NERC CIP and NIST® IR 7628 cyber security requirements.

This software option delivers the following core features:

### AAA Server Support (Radius/LDAP)

Enables integration with centrally managed authentication and accounting of all user activities and uses modern industry best practices and standards that meet and exceed NERC CIP requirements for authentication and password management.

### Role Based Access Control (RBAC)

Efficiently administrate users and roles within UR devices. The new and advanced access functions allow users to configure up to five roles for up to eight configurable users with independent passwords. The standard “Remote Authentication Dial In User Service” (Radius) is used for authentication.

### Event Recorder (Syslog for SEM)

Capture all cyber security related events within a SOE element (login, logout, invalid password attempts, remote/local access, user in session, settings change, FW update, etc), and then serve and classify data by security level using standard Syslog data format. This will enable integration with established SEM (Security Event Management) systems.

## Communications

The B90 provides for secure remote data and engineering access, making it easy and flexible to use and integrate into new and existing infrastructures. Fiber optic Ethernet provides high-bandwidth communications allowing for low-latency controls and high-speed file transfers of relay fault and event record information. The available three independent Ethernet ports and redundant Ethernet option provide the means to create fault tolerant communication architectures in an easy, cost-effective manner.

The B90 supports the most popular industry standard protocols enabling easy, direct integration into DCS and SCADA systems.

- IEC 61850 Ed. 2 with 61850-9-2 and 61850-90-5 support
- DNP 3.0 (serial & TCP/IP)
- Ethernet Global Data (EGD)
- IEC 60870-5-103 and IEC 60870-5-104
- Modbus RTU, Modbus TCP/IP
- HTTP, TFTP, SFTP and MMS file transfer
- SNTP and IEEE 1588 for time synchronization
- PRP as per IEC 62439-3
- Supports Routable GOOSE (R-GOOSE)

### Interoperability with Embedded IEC 61850 Edition 2

The new IEC 61850 implementation in the UR Family positions GE as an industry leader in this standard.

- Implements Edition 2 of the standard across the entire family of UR devices
- Provides full relay setting management via standard SCL files (ICD, CID and IID)
- Enables automated relay setting management using 3rd party tools through standard file transfer services (MMS and SFTP)
- Increases the number of Logical Devices and data mapped to them, GOOSE messages from up to 64 remote devices, and reports to support different organizational needs for data transfer and reduce dependency on generic logical nodes
- Configures GE Systems based on IEC 61850 using universal 3rd party tools
- R-GOOSE enable customer to send GOOSE messages beyond the substation, which enables Wide Area Protection & Control (WAPC) and more cost effective communication architectures for wide area applications

### Direct I/O Messaging

Direct I/O allows for the sharing of high-speed digital information between multiple UR relays via direct back-to-back connections or multiplexed through a standard DSO multiplexer channel bank. Regardless of the connection method, direct I/O provides continuous real-time channel monitoring that supplies diagnostics information on channel health.

Direct I/O provides superior relay-to-relay communications that can be used in advanced interlocking, and other special protection schemes.

- Communication with up to 16 UR relays in single or redundant rings rather than strictly limited to simplistic point-to-point configurations between two devices
- Connect to standard DSO channel banks through standard RS422, G.703 or IEEE C37.94 interfaces or via direct fiber optic connections
- No external or handheld tester required to provide channel diagnostic information

### LAN Redundancy

Substation LAN redundancy has been traditionally accomplished by reconfiguring the active network topology in case of failure. Regardless of the type of LAN architecture (tree, mesh, etc), reconfiguring the active LAN requires time to switchover, during which the LAN is unavailable. UR devices deliver redundancy as specified by PRP-IEC 62439-3, which eliminates the dependency on LAN reconfiguration and the associated switchover time. The UR becomes a dual attached node that transmits data packets over both main and redundant networks simultaneously, so in case of failure, one of the data packets will reach the receiving device with no time delay.

**Multi-Language**

UR devices support multiple languages: English, French, Russian, Chinese, Turkish and German. These language options are available on the front panel, in the EnerVista setup software, and in the product manuals. Easily switch between English and an additional language on the local displays without uploading new firmware.

**EnerVista Software**

The EnerVista suite is an industry-leading set of software programs that simplifies every aspect of using the B90 relay. The EnerVista suite provides all the tools to monitor the status of the protected asset, maintain the relay, and integrate information measured by the B90 into DCS or SCADA monitoring systems. Convenient COMTRADE and SOE viewers are an integral part of the UR setup software included with every UR relay, to carry out postmortem event analysis and ensure proper protection system operation.

**EnerVista Launchpad**

EnerVista Launchpad is a powerful software package that provides users with all of the setup and support tools needed for configuring and maintaining Multilin products. The setup software within Launchpad allows for the configuration of devices in real-time by communicating using serial, Ethernet, or modem connections, or offline by creating setting files to be sent to devices at a later time.

Included in Launchpad is a document archiving and management system that ensures critical documentation is up-to-date and available when needed. Documents made available include:

- Manuals
- Application Notes
- Guideform Specifications
- Brochures
- Wiring Diagrams
- FAQs
- Service Bulletins

**Viewpoint UR Engineer**

Viewpoint UR Engineer is a set of powerful tools that allows the configuration and testing of GE relays at a system level in an easy-to-use graphical drag-and-drop environment. Viewpoint UR Engineer provides the following configuration and commissioning utilities:

- Graphical Logic Designer
- Graphical System Designer
- Graphical Logic Monitor
- Graphical System Monitor

**EnerVista Integrator**

EnerVista Integrator is a toolkit that allows seamless integration of Multilin devices into new or existing automation systems. Included in EnerVista Integrator is:

- OPC/DDE Server
- Multilin Drivers
- Automatic Event Retrieval
- Automatic Waveform Retrieval

**Simplifying Commissioning and Testing**

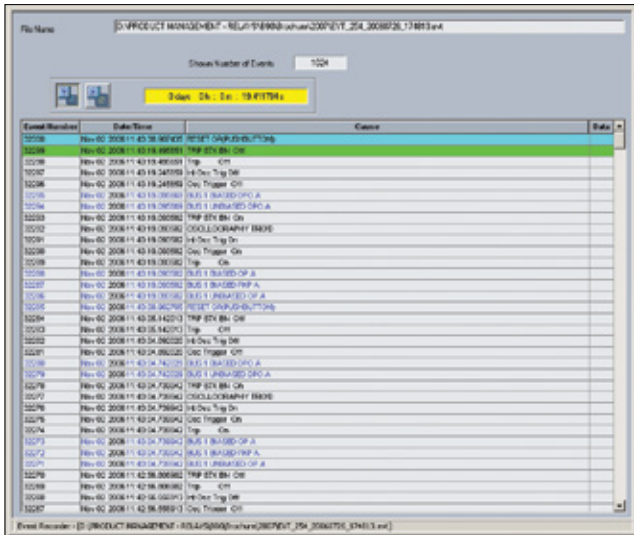

## User Interface

The B90 front panel provides extensive local HMI capabilities. The local display is used for monitoring, status messaging, fault diagnosis, and device configuration. User-configurable messages that combine text with live data can be displayed when user-defined conditions are met.

48 Configurable LED Indicators



Multi-Language Display

- English
- Russian
- French
- Chinese
- Turkish
- German

User-Programmable Pushbuttons

## Typical Wiring

The B90 is a multi-IED protection scheme. Each IED may be ordered with different hardware components and must be wired accordingly. The following drawing illustrates the principles behind a typical B90 wiring.

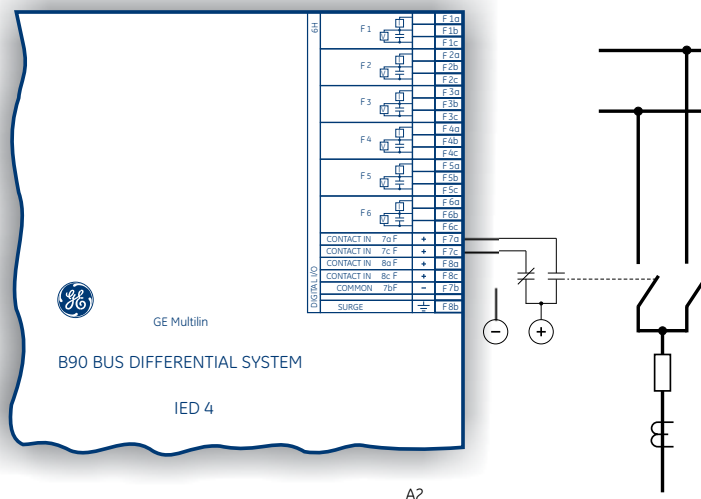
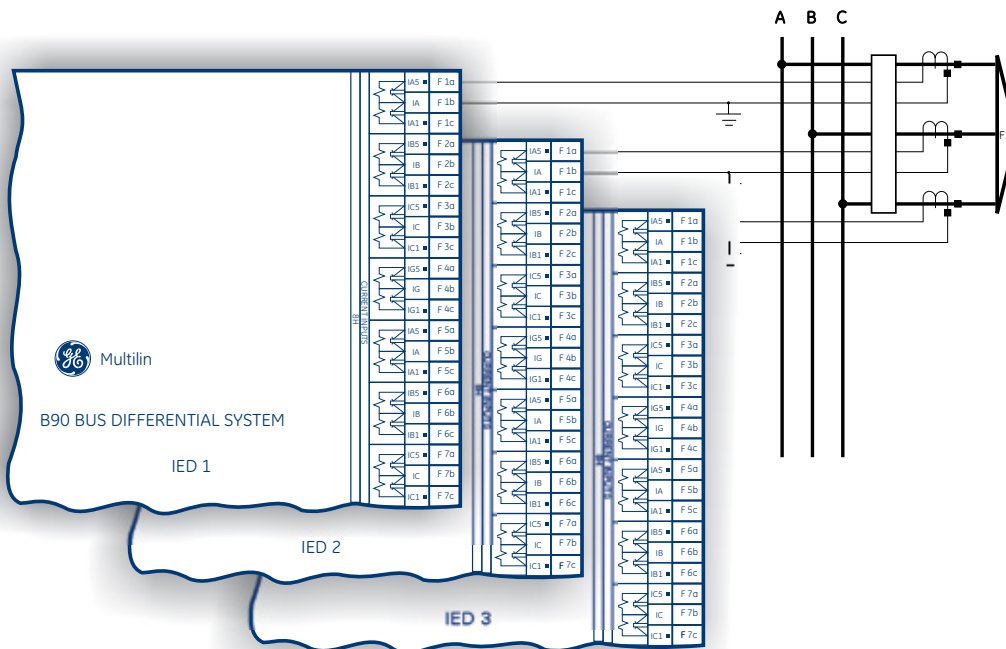

A2

# Ordering

(Please Contact GE Energy for Engineered Bus Protection Solutions)

	B90	-	*	*	-H	*	-	F**	H**	L**	N**	S**	U**	-W/X**	For full sized horizontal mount
Base Unit	B90														Base Unit
CPU		E	G	H	J	K	N	T	U	V					RS485 + RS485 (IEC 61850 option not available)
Software Options (see note 1 below)		0	1												RS485 + 10BaseF
Mount/ Coating				H	A										RS485 + Redundant 10BaseF
User Interface					F	I	J	K	L	M	N	O	T	U	RS485 + multimode ST 100BaseFX
Power Supply (see note 2 below)					H	L									RS485 + multimode ST Redundant 100BaseFX
CT/VT DSP								8F		8F		8F			RS485 + 10/100 BaseT
Digital I/O								8H		8H		8H			RS485 + three multimode SFP LC 100BaseFX. Req FW v7xx or higher
Inter-Relay Communications								8K		8K		8K			RS485 + two multimode SFP LC 100BaseFX + one SFP RJ45 100BaseT. Req FW v7xx or higher
															RS485 + three SFP RJ45 100BaseT. Req FW v7xx or higher
															Without Breaker Failure
															With Breaker Failure (With Engineered Solution Only)
															8-feeders, 06 zones
															16-feeders, 06 zones
															24-feeders, 06 zones
															8-feeders, 06 zones, IEC 61850
															16-feeders, 06 zones, IEC 61850
															24-feeders, 06 zones, IEC 61850
															CyberSentry UR Lvl 1 + 08 feeders, 06 zones
															IEEE 1588 + 08 feeders, 06 zones
															PRP
															IEEE 1588 + CyberSentry UR Lvl 1 + 08 feeders, 06 zones
															Horizontal (19" rack)
															Horizontal (19" rack) - Harsh Chemical Environment Option
															Vertical Front Panel with English Display
															Enhanced German Front Panel
															Enhanced German Front Panel with User-Programmable Pushbuttons
															Enhanced English Front Panel
															Enhanced English Front Panel with User-Programmable Pushbuttons
															Enhanced French Front Panel
															Enhanced French Front Panel with User-Programmable Pushbuttons
															Enhanced Russian Front Panel
															Enhanced Russian Front Panel with User-Programmable Pushbuttons
															Enhanced Chinese Front Panel
															Enhanced Chinese Front Panel with User-Programmable Pushbuttons
															Enhanced Turkish Front Panel
															Enhanced Turkish Front Panel with User-Programmable Pushbuttons
															125 / 250 V AC/DC
															125 / 250 V AC/DC with redundant 125/250 V AC/DC
															24 - 48 V (DC only)
															Standard 4CT/4VT
															Standard 8CT
															Standard 7CT/1VT
															No module
															4 Solid State (No Monitoring) MOSFET Outputs
															4 Solid State (Current w/opt Voltage) MOSFET Outputs
															16 Digital Inputs with Auto-Burnish
															14 Form-A (No Monitoring) Latchable Outputs
															8 Form-A (No Monitoring) Outputs
															8 Form-C Outputs
															16 Digital Inputs
															4 Form-C Outputs, 8 Digital Inputs
															8 Fast Form-C Outputs
															4 Form-C & 4 Fast Form-C Outputs
															2 Form-A (Current w/ opt Voltage) & 2 Form-C Outputs, 8 Digital Inputs
															2 Form-A (Current w/ opt Voltage) & 4 Form-C Outputs, 4 Digital Inputs
															4 Form-A (Current w/ opt Voltage) Outputs, 8 Digital Inputs
															6 Form-A (Current w/ opt Voltage) Outputs, 4 Digital Inputs
															2 Form-A (No Monitoring) & 2 Form-C Outputs, 8 Digital Inputs
															2 Form-A (No Monitoring) & 4 Form-C Outputs, 4 Digital Inputs
															4 Form-A (No Monitoring) Outputs, 8 Digital Inputs
															6 Form-A (No Monitoring) Outputs, 4 Digital Inputs
															Channel 1 - IEEE C37.94, 820nm, multimode fiber, 64/128 kbps; Channel 2 - 1300 nm, singlemode, LASER
															Channel 1 - IEEE C37.94, 820nm, multimode fiber, 64/128 kbps; Channel 2 - 1550 nm, singlemode, LASER
															7A 820 nm, multimode, LED, 1 Channel
															7B 1300 nm, multimode, LED, 1 Channel
															7H 820 nm, multimode, LED, 2 Channels
															7I 1300 nm, multimode, LED, 2 Channels
															7S G.703, 2 Channels
															7W RS422, 2 Channels
															77 IEEE C37.94, 820 nm, multimode, LED, 2 Channel

## Ordering Notes:

- To view all the options available for B90, please visit GE's On-Line Store at <http://store.gedigitalenergy.com/viewprod.asp?model=B90D>
- Redundant power supply only available in horizontal unit. If redundant is chosen, must be same type. Maximum 2 per chassis
- All "06 zones" software options become "04 zones" when FW version prior to 7.30 is ordered.

## GEGridSolutions.com

IEC is a registered trademark of Commission Electrotechnique Internationale. IEEE is a registered trademark of the Institute of Electrical Electronics Engineers, Inc. Modbus is a registered trademark of Schneider Automation. NERC is a registered trademark of North American Electric Reliability Council. NIST is a registered trademark of the National Institute of Standards and Technology.

GE, the GE monogram, Multilin, FlexLogic, EnerVista and CyberSentry are trademarks of General Electric Company.

GE reserves the right to make changes to specifications of products described at any time without notice and without obligation to notify any person of such changes.

Copyright 2017, General Electric Company. All Rights Reserved.

GEA-125880(E)  
English  
170130



imagination at work